

IT IS HIGHLY RECOMMENDED THAT THE INSTRUCTIONS BE READ THROUGH BEFORE INSTALLING DOOR.



INSPIRE

ELEGANT PLEATED RETRACTABLE SCREEN DOOR **INSTALLATION INSTRUCTIONS** for RECESS/INSIDE MOUNTING ONLY

INSTALLATION TOOLS

PHILLIPS SCREWDRIVER

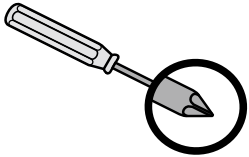

MEASURING TAPE

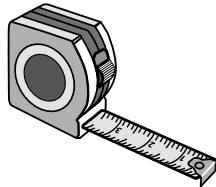

HAND-HELD OR POWER SAW

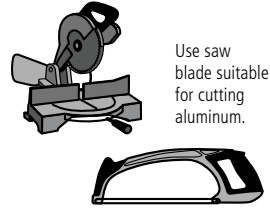

POWER DRILL & BITS

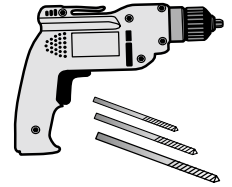

INSTALLATION PREP

1 MEASURING

Measure the door opening width and height as shown in the diagrams below and record the smallest width and height measurement [2-A or 2-B].

2-A Recess Installation

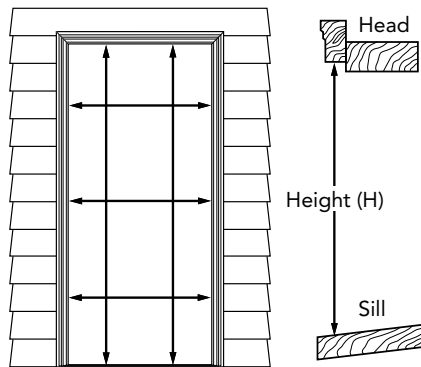
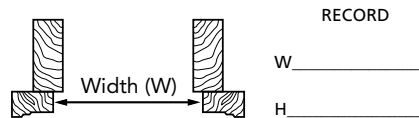

2-B Alternate Recess Installation

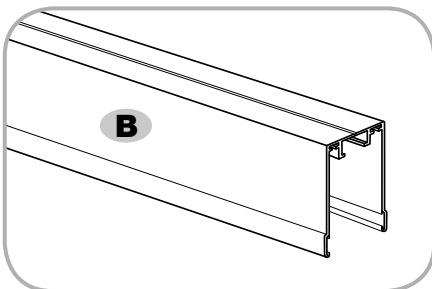
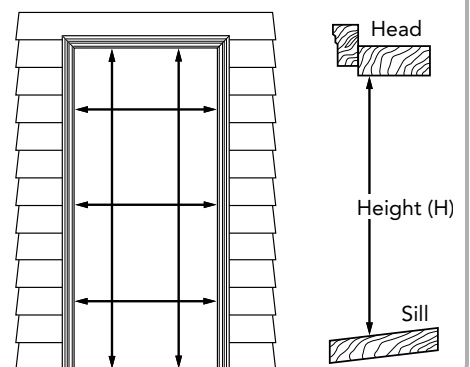
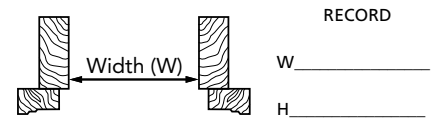

2 CUTTING INSTRUCTIONS

The **B-Top Guide** should be trimmed to match the same measurement as the width of the door opening. The **B-Top Guide** also comes with optional adjustable **F-Plastic Top Guide End Caps**. The pieces are elective parts yet they can be useful for covering rough or inexact cuts or to aesthetically cover any gap if the **B-Top Guide** protrudes beyond the door frame. If you decide to use these adjustable **Top Guide End Caps** you will need to deduct 3/16" (6mm) from the size of the opening width.

_____ (W) - 3/16" = _____

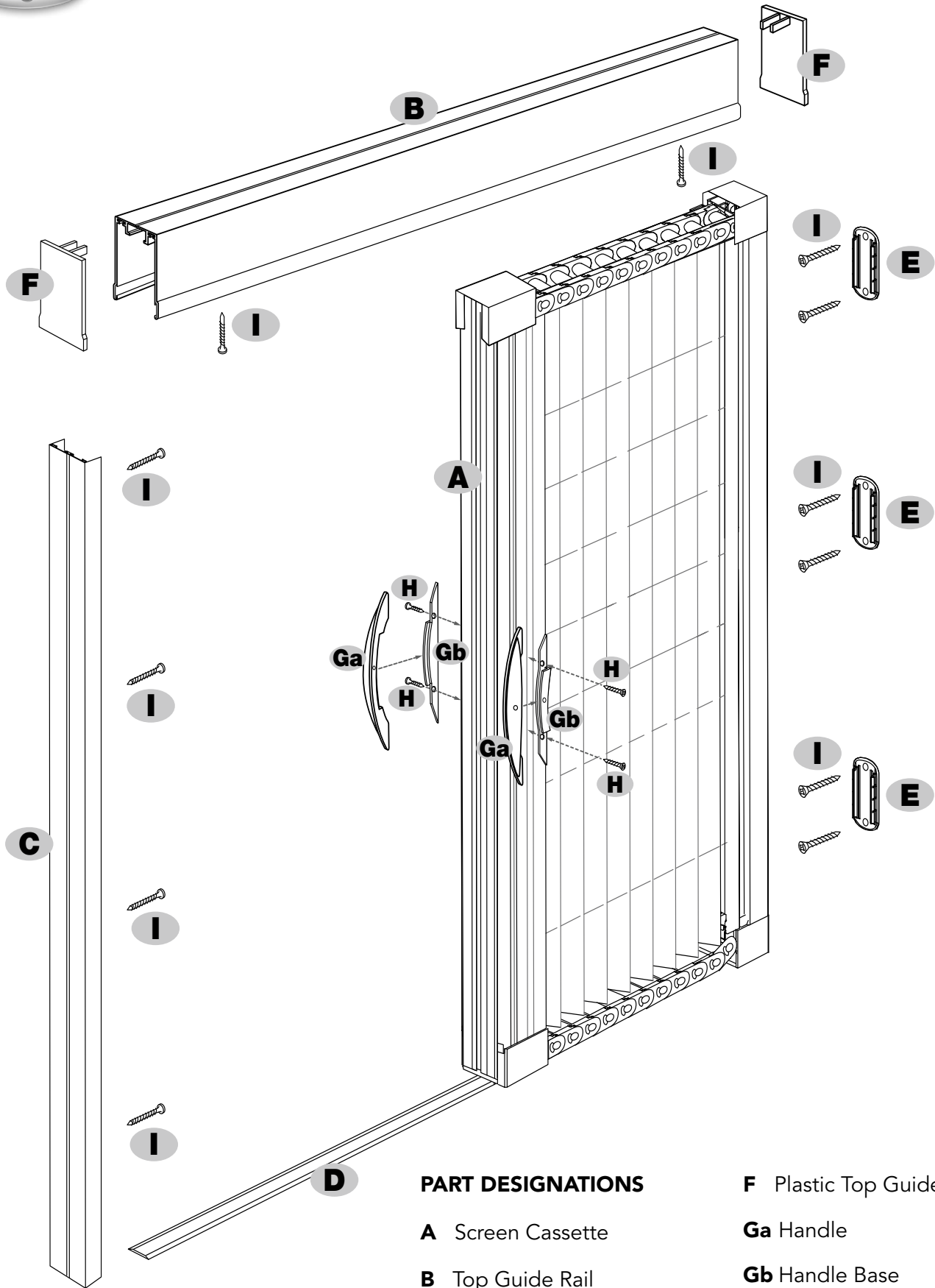

PART DESIGNATIONS

A Screen Cassette

B Top Guide Rail

C Side Profile (optional)

D PVC Bottom Guide

E Recess Mount Brackets

F Plastic Top Guide End Caps

Ga Handle

Gb Handle Base

H #8 x 1/2" (12mm)

Phillip Flathead

Self-Starting Screws

I #8 x 3/4" (19mm) Screws

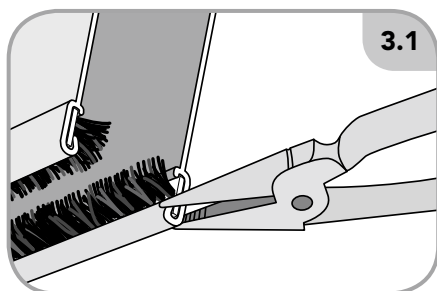
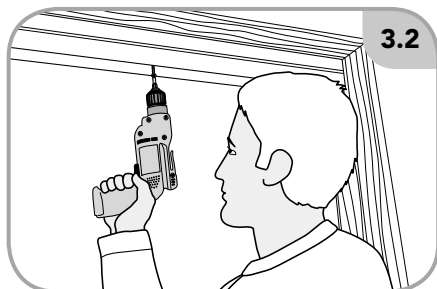
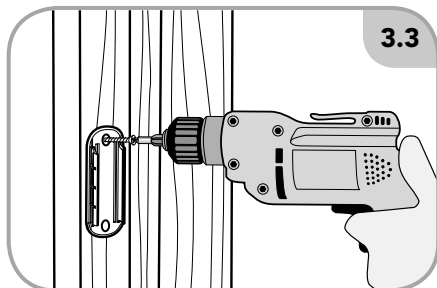
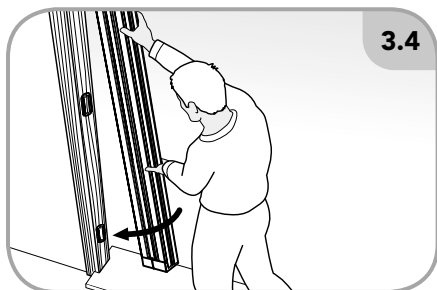
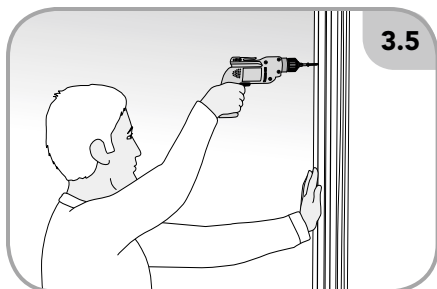
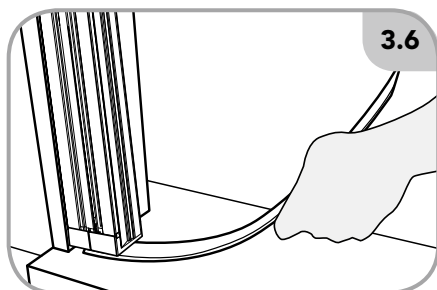
INSTALLATION

3.1

3.2

3.3

3.4

3.5

3.6

3 ASSEMBLY & INSTALLATION

3.1 : Using pliers, gently crimp the ends of the weather strip channels on **B-Top Guide** so that the weather strips stay in place.

3.2 : Drill pilot holes and attach the **B-Top Guide** to the door frame using two (2) I-#8 x 3/4" (19mm). Space screws 6" (150mm) from either end. Optional **F-Plastic Top Guide End Caps** are provided that cap the ends of the **Guide** in instances where the **B-Top Guide Rail** does not rest fully inside the door frame.

3.3 : Install the three **E-Recess Mount Brackets** at the side jamb where the **A-Cassette Screen** will be located. **NOTE: Make sure the E-Recess Mount Brackets are centered in relationship to the B-Top Guide installed in 3.1. When the A-Screen Cassette is snapped on to the Bracket, it will need to fit up and into the B-Top Guide cleanly. The E-Recess Mount Brackets have an adhesive backing to help make the initial positioning easier. Remove the paper covering to expose the adhesive and position the E-Recess Mount Brackets 6" from the top and the bottom, and equally space the remaining brackets. Make sure the E-Recess Mount Brackets are aligned and plumb and allow 3/8" (10mm) free space on each side so that the A-Screen Cassette can easily snap into place. Drill 1/8" (3mm) pilot holes and attach the Mount Brackets with the six (6) I-#8 x 3/4" (19mm) Screws provided.**

3.4 : DO NOT OPEN THE SCREEN UNTIL INSTALLED IN THE OPENING

Note that one end of the **A-Screen Cassette** is labeled with a sticker indicating that it is the **TOP** end. Position the **A-Screen Cassette** so that the top tucks within and rests inside the **B-Top Guide Rail**. Snap the **A-Screen Cassette** onto the **E-Recess Mount Brackets**, making sure that the **Cassette** is attached securely to all **Brackets**.

3.5 : WITH SINGLE DOOR SCREENS, USE OF THE C-SIDE PROFILE IS OPTIONAL AND CAN BE ELIMINATED IF IT INTERFERES WITH THE DOOR HANDLE OR AESTHETICS OF THE DOOR. Drill 1/8" (3mm) pilot holes at 3" (76mm) in from either end of the **C-Side Profile**. Drill two more holes evenly spaced between. Attach the **C-Side Profile** to the opposite side of the door jamb using four I-#8 x 3/4" (19mm) Screws. The **C-Side Profile** should fit slightly up into the **B-Top Guide**.

3.6 : With a saw or utility knife, cut the **D-Bottom Guide** to 1/4" less than the door opening. Clean the installation area beforehand so that the **D-Bottom Guide** adheres firm and flat. Using the **A-Screen Cassette** and **C-Side Profile** as a reference, mark a centering line with a pencil onto the doorsill. This line will identify the center position of the **D-Bottom Guide** and help make sure that it is applied straight and centered. The **D-Bottom Guide** has a convenient double-stick tape strip on the bottom. Using the centering line as a reference, slide one end of the **D-Bottom Guide** underneath the **A-Screen Cassette** until it contacts the side jamb of the door frame. From the opposite end of the **D-Bottom Guide**, pull away and remove the paper covering on the adhesive strip. Align the **D-Bottom Guide** on the centering line, lower to the sill and apply firm pressure to activate the adhesive. If preferred, or on multiple panel screens, install the **D-Bottom Guide** before clipping on the **A-Screen Cassette**. For the tape to properly adhere the surface must be dry and the surrounding temperature must exceed 45 degrees Fahrenheit (7 degrees Celsius).

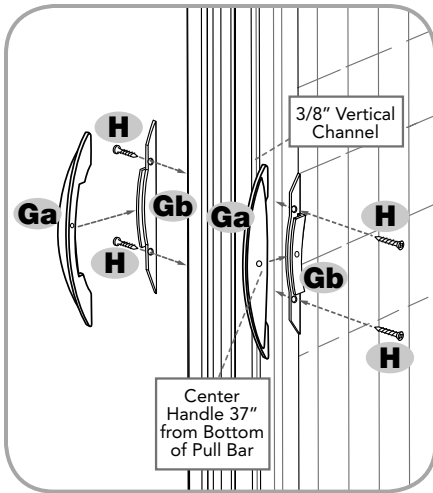

4 INSTALLING HANDLES (optional)

The screen comes with two metal **G-Handles** that can be positioned and installed on the pull bar of the **A-Screen Cassette**. Locate the 3/8" wide vertical slot down the center of the **A-Screen Cassette Pull Bar**. Measure up 37" from the bottom of the **A-Screen Cassette** and center the **G-Handle** at that mark. The handle may be placed higher or lower if desired. There are two parts for the **G-Handle**. **Gb-Handle Base** has two screw holes, with an elevated second flange. The bottom part of this piece fits into the 3/8" vertical slot on the **A-Screen Cassette Pull Bar**. Position as desired and attach using **H-#8 x 1/2"(12mm) Phillips Flathead Self-starting Screws**. **DO NOT PRE-DRILL** holes or you may critically damage components that are located inside the **A-Screen Cassette Pull Bar**. **NOTE: Make sure that the arch of the G-Handle points toward the door end (see illustration at left).** Next, slide the **Ga-Handle** on to the elevated flange of the **Gb-Handle Base**. It will fit securely over the base. There is a hex-screw pre-installed in **Ga-Handle**. When properly aligned over **Gb-Handle Base**, tighten to secure **Ga-Handle** to the **A-Screen Cassette Pull Bar**.

APPENDIX A

MULTIPLE SCREEN PANEL SYSTEMS

Please note that all double panel and multiple panel Inspire screens use a full length magnetic seal (rather than pile weather strip seal at the leading edge of the A-Screen Cassette pull bar). Panels can be rotated to operate left or right.

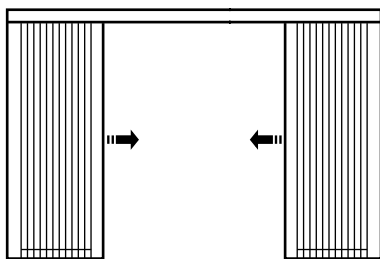

4.1 CENTER LATCHING DOUBLE PANEL SCREENS

Note that this configuration does not use a C-Side Profile but instead uses two A-Screen Cassettes with one being installed at each side jamb of the door opening. Follow the instructions beginning at Step 1. At Step 2.1 install three E-Recess Mount Brackets at each side jamb where the cassettes will be located. During Step 2.3 take care to add additional screws when installing the B-Top Guide Rail.

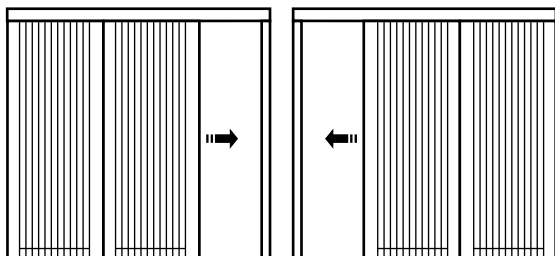

4.2 SIDE LATCHING DOUBLE PANEL SCREENS

Note that this configuration uses a C-Side Profile on one side of the opening with two A-Screen Cassettes being installed at the opposite side jamb. Follow step 1 and 2.1, 2.2 and 2.3 while being certain to add additional screws to when installing the B-Top Guide Rail. Locate the A-Screen Cassette that does NOT have the full length magnetic seal at the leading edge of the pull bar. This will be the first screen panel to install on the E-Recess Mount Brackets. Rotate the A-ScreenCassette so

that the open back edge aligns with the E-Recess Mount Brackets and snap the screen cassette to the brackets. Take the A-Screen Cassette with the full length magnetic seal at the leading edge of the pull bar. Position the side without the magnet so that it aligns with the first A-Screen Cassette and snap together the cassettes. Continue the installation at Step 2.5 and 3.

APPENDIX A cont.

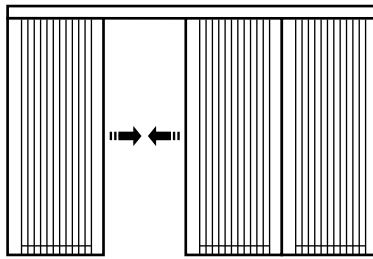
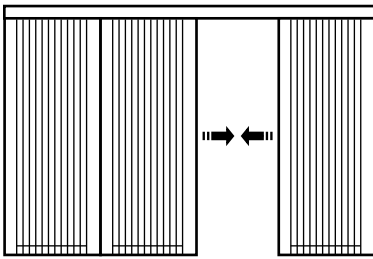

4.3 CENTER LATCHING TRIPLE PANEL SCREENS

Note that this configuration does not use a C-Side Profile but instead uses three A-Screen Cassettes with two being installed at one side jamb and one at the opposite side jamb of the door opening. Follow step 1 and 2.1, 2.2 and 2.3 (2.4 does not apply). Be certain to add

additional screws when installing the B-Top Guide Rail. Note that in step 2.1 you will install three E-Recess Mount Brackets at each side jamb where cassettes will be located. For the side with only a single screen panel, locate one of the A-Screen Cassette with the full length magnetic seal at the leading edge of the pull bar. Position the side without the magnet so that it aligns with the three E-Recess Mount Brackets and snap into place. For the side with the double screen panels locate the A-Screen Cassette that does NOT have the full length magnetic seal at the leading edge of the pull bar. This will be the first screen panel to install on the E-Recess Mount Brackets. Rotate the A-Screen Cassette so that the open back edge aligns with the E-Recess Mount Brackets and snap the screen cassette to the brackets. Take the A-Screen Cassette with the full length magnetic seal at the leading edge of the pull bar, position the side without the magnet so that it aligns with the first A-Screen Cassette and snap together the cassettes. Continue the installation at Step 3.

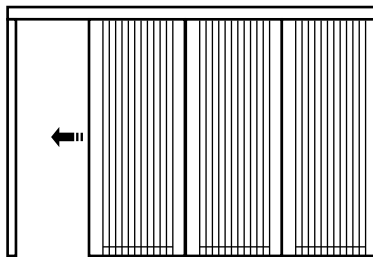
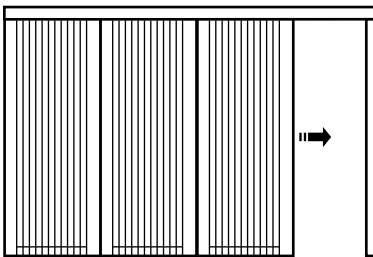

4.4 SIDE LATCHING TRIPLE PANEL SCREENS

Note that this configuration uses a C-Side Profile on one side of the opening with three A-Screen Cassettes being installed at the opposite side jamb. Follow step 1 and 2.1, 2.2 and 2.3 while being certain to add additional screws when installing the B-Top Guide Rail. Install the three E-Recess Mount Brackets at the side jamb where

the cassettes will be placed. Locate one of the A-Screen Cassettes that does NOT have the full length magnetic seal at the leading edge of the pull bar. This will be the first screen panel to install on the E-Recess Mount Brackets. Rotate the A-Screen Cassette so that the open back edge aligns with the E-Recess Mount Brackets and snap the screen cassette to the brackets. Locate the other A-Screen Cassette that does NOT have the full length magnetic seal at the leading edge of the pull bar. This will be the second screen panel to install. Rotate the A-Screen Cassette so that the open back edge aligns with the black plastic connection strip of the first A-Screen Cassette and snap together the screen cassettes. Take the A-Screen Cassette with the full length magnetic seal at the leading edge of the pull bar. Position the side without the magnet so that it aligns with the second A-Screen Cassette and snap together the screen cassettes. Continue the installation at Step 2.5 and 3.

